



MARINE EQUIPMENT

made to last

A blue-tinted photograph of a marina filled with numerous sailboats, their masts and rigging creating a dense pattern against a bright sky.

CLASSIC CATALOGUE



Content	Page
Blocks	
Aluminium Blocks - Plan Bearing	3, 4, 5, 6
Aluminium Blocks - Ball Bearing	7, 8, 9
Wire Blocks	6, 9, 15, 17
Lead Blocks	16, 17
Big Boat Aluminium Blocks - Ball Bearing	10, 11
Stainless Steel Blocks - Plan Bearing	12, 13, 14, 15
Stoppers - Cleats	
Halyard Stoppers	18
Cam Cleats	19
Fairleads	19
Genoa - Reefing Slides	
Slides 20 mm	19
Stainless Steel Slides 25 mm	19, 20
Aluminium T-Track Cars - Stops	
Tracks 20 mm - 32mm	19
Stops 20 mm - 32 mm	20, 21
Cars 25 mm - 32 mm	20, 21
Spinnaker Pole Cars 25 mm - 32 mm	21
Anchor Line Cassettes - Skin Fittings - Shackles - etc.	
Anchor Line Cassettes	18
Ball valves	23
Pad eyes	23
Pin Bolts, Stainless Steel	24
Shackles, Stainless Steel	23
Sheaves, Aluminium and Delrin	24
Skin- and Tube Fittings, Stainless Steel	22, 23
Split Rings, Stainless Steel	23
Springs, Stainless Steel	23
Swivels, Stainless Steel	23

Aluminium Blocks - Plan Bearing



Single



Single with becket



Single with swivel



Single with snap shackle

Cat.no.	Sheave sizes	Max working load	Cat.no.	Sheave sizes	Max working load	Cat.no.	Sheave sizes	Max working load	Cat.no.	Sheave sizes	Max working load
00101	35 x 10 mm	300 kg	00102	35 x 10 mm	300 kg	00103	35 x 10 mm	300 kg	00123	35 x 10 mm	300 kg
01012	35 x 16 mm	500 kg	00202	45 x 12 mm	500 kg	00203	45 x 12 mm	500 kg	00223	45 x 12 mm	500 kg
00201	45 x 12 mm	500 kg	00302	45 x 16 mm	625 kg	00303	45 x 16 mm	625 kg	00323	45 x 16 mm	625 kg
00301	45 x 16 mm	625 kg	03022	57 x 16 mm	775 kg	03032	57 x 16 mm	775 kg	03232	57 x 16 mm	775 kg
03012	57 x 16 mm	775 kg	00402	65 x 16 mm	950 kg	00403	65 x 16 mm	950 kg	00423	65 x 16 mm	950 kg
00401	65 x 16 mm	950 kg				00503	65 x 18 mm	1350 kg	All blocks with swivel are available with snap shackle		
						00603*	65 x 18 mm	1800 kg			



Single with swivel and becket



Single with swivel plate



Spring base stand-up block



Single with becket and swivel plate

Cat.no.	Sheave sizes	Max working load	Cat.no.	Sheave sizes	Max working load	Cat.no.	Sheave sizes	Max working load	Cat.no.	Sheave sizes	Max working load
00104	35 x 10 mm	300 kg	00105	35 x 10 mm	300 kg	03052	57 x 16 mm	775 kg	00106	35 x 10 mm	300 kg
00204	45 x 12 mm	500 kg	00205	45 x 12 mm	500 kg	00405	65 x 16 mm	950 kg	00206	45 x 12 mm	500 kg
00304	45 x 16 mm	625 kg	00305	45 x 16 mm	625 kg	Also available with aluminium sheave for rope or wire		00306	45 x 16 mm	625 kg	
03042	57 x 16 mm	775 kg									
00404	65 x 16 mm	950 kg									
00504	65 x 18 mm	1350 kg									
00604*	65 x 18 mm	1800 kg									

*= with stainless steel straps and aluminium sheave



Aluminium Blocks - Plan Bearing



Spring base stand-up block with becket



Double



Double with becket



Double with swivel

Cat.no.	Sheave sizes	Max working load	Cat.no.	Sheave sizes	Max working load	Cat.no.	Sheave sizes	Max working load	Cat.no.	Sheave sizes	Max working load
03062	57 x 16 mm	775 kg	00107	35 x 10 mm	300 kg	00108	35 x 10 mm	300 kg	00109	35 x 10 mm	300 kg
00406	65 x 16 mm	950 kg	00207	45 x 12 mm	500 kg	00208	45 x 12 mm	500 kg	00209	45 x 12 mm	500 kg
Also available with aluminium sheave for rope or wire			00307	45 x 16 mm	625 kg	00308	45 x 16 mm	625 kg	00309	45 x 16 mm	625 kg
			03092	57 x 16 mm	775 kg	00409	65 x 16 mm	950 kg	00509	65 x 18 mm	1350 kg

These blocks are available in natural (n) or black (s) anodised aluminium (00103n or 00103s)



Double with swivel and becket



Fiddle

Cat.no.	Sheave sizes	Max working load	Cat.no.	Sheave sizes	Max working load
00110	35 x 10 mm	300 kg	00112	45/25x10 mm	300 kg
00210	45 x 12 mm	500 kg	00212	57/32x12 mm	500 kg
00310	45 x 16 mm	625 kg	00312	57/32x16 mm	625 kg
03102	57 x 16 mm	775 kg			
00410	65 x 16 mm	950 kg			
00510	65 x 18 mm	1350 kg			

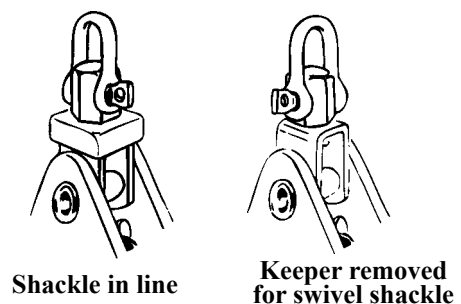
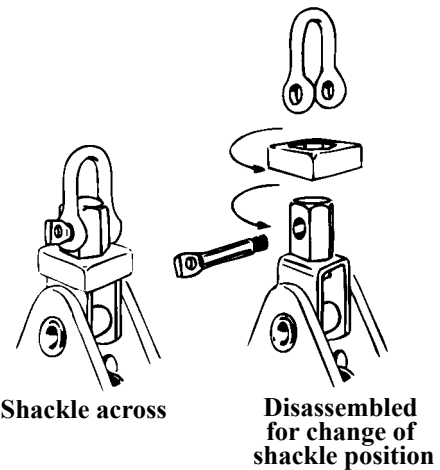

Aluminium Blocks - Plan Bearing



Fiddle with becket



Fiddle with swivel



Fiddle with swivel



Fiddle with swivel and becket

Cat.no.	Sheave sizes	Max working load	Cat.no.	Sheave sizes	Max working load	Cat.no.	Sheave sizes	Max working load	Cat.no.	Sheave sizes	Max working load
00113	45/25 x 10 mm	300 kg	00114	45/25 x 10 mm	300 kg	00414	45 x 16 mm	950 kg	00115	45/25 x 10 mm	300 kg
00213	57/32 x 12 mm	500 kg	00214	57/32 x 12 mm	500 kg	00514	49 x 18 mm	1350 kg	00215	57/32 x 12 mm	500 kg
00313	57/32 x 16 mm	625 kg	00314	57/32 x 16 mm	625 kg				00315	57/32 x 16 mm	625 kg



Fiddle with swivel and becket



Fiddle with cam cleat adjustable to 5 positions



Fiddle with swivel and cam cleat adjustable to 5 positions



Fiddle with swivel, becket and cam cleat

Cat.no.	Sheave sizes	Max working load	Cat.no.	Sheave sizes	Max working load	Cat.no.	Sheave sizes	Max working load	Cat.no.	Sheave sizes	Max working load
00415	45 x 16 mm	950 kg	00116	45/25 x 10 mm	300 kg	00117	45/25 x 10 mm	300 kg	00417	45 x 16 mm	950 kg
00515	49 x 18 mm	1350 kg	00216	57/32 x 12 mm	500 kg	00217	57/32 x 12 mm	500 kg	00517	49 x 18 mm	1350 kg
			00316	57/32 x 16 mm	625 kg	00317	57/32 x 16 mm	625 kg			



Aluminium Blocks - Plan Bearing



Triple with swivel



Triple with swivel and becket



Triple with swivel, becket and cam cleat



Single with swivel, becket and cam cleat

Cat.no.	Sheave sizes	Max working load	Cat.no.	Sheave sizes	Max working load	Cat.no.	Sheave sizes	Max working load	Cat.no.	Sheave sizes	Max working load
00119	35 x 10 mm	300 kg	00120	35 x 10 mm	300 kg	00221	45 x 12 mm	500 kg	00224	45 x 12 mm	500 kg
00219	45 x 12 mm	500 kg	00220	45 x 12 mm	500 kg	03212	57 x 16 mm	775 kg	03242	57 x 16 mm	775 kg
00319	45 x 16 mm	625 kg	00320	45 x 16 mm	625 kg	00421	65 x 16 mm	950 kg	00424	65 x 16 mm	950 kg
03192	57 x 16 mm	775 kg	03202	57 x 16 mm	775 kg	00521	65 x 18 mm	1350 kg			
00419	65 x 16 mm	950 kg	00420	65 x 16 mm	950 kg						
00519	65 x 18 mm	1350 kg	00520	65 x 18 mm	1350 kg						



Wire block with aluminium sheave



Block with swivel and aluminium sheave for rope or wire



Back stay tension block with aluminium sheaves for max 6 mm wire



Back stay tension block with delrin sheaves for max 6 and 8 mm wire

Cat.no.	Sheave sizes	Max working load	Cat.no.	Sheave sizes	Max working load	Cat.no.	Sheave sizes	Max working load	Cat.no.	Sheave sizes	Max working load
00351	35 x 8 mm	300 kg	00454	45 x 12 mm	500 kg	00235	35 x 8 mm	775 kg	00236	32 x 12 mm	800 kg
00451	45 x 8 mm	500 kg	00455	57 x 16 mm	775 kg				00237	45 x 16 mm	1200 kg
00551	65 x 12 mm	950 kg	00456	65 x 16 mm	950 kg						

Aluminium Blocks - Ball Bearing



Single



Single with swivel



Single with snap shackle



Single with swivel and becket

Cat.no.	Sheave sizes	Max working load	Cat.no.	Sheave sizes	Max working load	Cat.no.	Sheave sizes	Max working load	Cat.no.	Sheave sizes	Max working load
701012	35 x 16 mm	500 kg	700303	45 x 16 mm	625 kg	700323	45 x 16 mm	625 kg	700304	45 x 16 mm	625 kg
			703032	57 x 16 mm	775 kg	703232	57 x 16 mm	775 kg	703042	57 x 16 mm	775 kg
			700403	65 x 16 mm	950 kg	700423	65 x 16 mm	950 kg	700404	65 x 16 mm	950 kg
			All blocks with swivel are available with snap shackle								

OH ball bearing blocks are produced with 3 rows of stainless steel ball bearings, which gives the sheave a smoother running and secures a longer lifetime. These blocks are only available in black anodised aluminium with white sheaves.



Spring base stand-up block



Spring base stand-up block with becket

Cat.no.	Sheave sizes	Max working load	Cat.no.	Sheave sizes	Max working load
703052	57 x 16 mm	775 kg	703062	57 x 16 mm	775 kg
700405	65 x 16 mm	950 kg	700406	65 x 16 mm	950 kg

BALL BEARING SHEAVE CONSTRUCTION

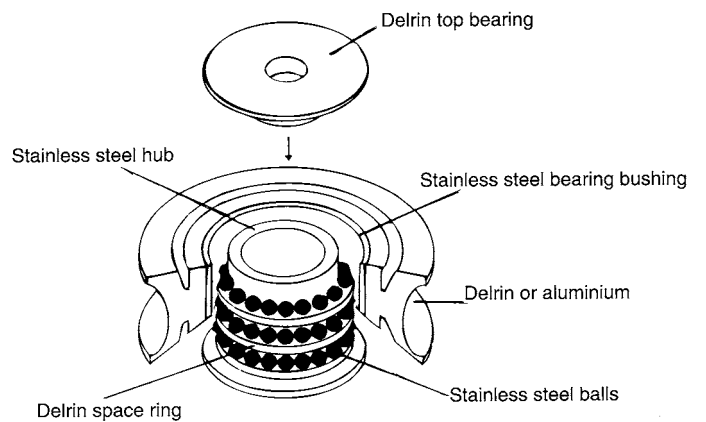



Aluminium Blocks - Ball Bearing



Double with swivel



Double with swivel and becket



Fiddle with swivel

Cat.no.	Sheave sizes	Max working load	Cat.no.	Sheave sizes	Max working load	Cat.no.	Sheave sizes	Max working load
700309	45 x 16 mm	625 kg	700310	45 x 16 mm	625 kg	700314	57/32 x 16 mm	625 kg
703092	57 x 16 mm	775 kg	703102	57 x 16 mm	775 kg			
700409	65 x 16 mm	950 kg	700410	65 x 16 mm	950 kg			



Fiddle with swivel



Fiddle with swivel and becket



Fiddle with swivel and becket

Cat.no.	Sheave sizes	Max working load	Cat.no.	Sheave sizes	Max working load	Cat.no.	Sheave sizes	Max working load
700414	45 x 16 mm	950 kg	700315	57/32 x 16 mm	625 kg	700415	45 x 16 mm	950 kg

Aluminium Blocks - Ball Bearing



Fiddle with swivel and cam cleat adjustable to 5 positions



Fiddle with swivel, becket and cam cleat



Triple with swivel

Cat.no.	Sheave sizes	Max working load	Cat.no.	Sheave sizes	Max working load	Cat.no.	Sheave sizes	Max working load
700317	57/32 x 16 mm	625 kg	700417	45 x 16 mm	950 kg	700319	45 x 16 mm	625 kg
						703192	57 x 16 mm	775 kg
						700419	65 x 16 mm	950 kg



Triple with swivel and becket



Triple with swivel, becket and cam cleat



Single with swivel and aluminium sheave for rope and wire

Cat.no.	Sheave sizes	Max working load	Cat.no.	Sheave sizes	Max working load	Cat.no.	Sheave sizes	Max working load
700320	45 x 16 mm	625 kg	703212	57 x 16 mm	775 kg	700455	57 x 16 mm	775 kg
703202	57 x 16 mm	775 kg	700421	65 x 16 mm	950 kg	700456	65 x 16 mm	950 kg
700420	65 x 16 mm	950 kg						



Big Boat Aluminium Blocks - Ball Bearing



Single with swivel



Single with snap shackle



Single with swivel and becket

Delrin sheaves Cat.no.	Ball bearing alu. sheaves Cat.no.	Sheave sizes	Max working load	Delrin sheaves Cat.no.	Ball bearing alu. sheaves Cat.no.	Sheave sizes	Max working load	Delrin sheaves Cat.no.	Ball bearing alu. sheaves Cat.no.	Sheave sizes	Max working load
00803	700803	75 x 20 mm	1800 kg	00823	700823	75 x 20 mm	1800 kg	00804	700804	75 x 20 mm	1800 kg
	700903	100 x 25 mm	2800 kg		700923	100 x 25 mm	2800 kg		700904	100 x 25 mm	2800 kg
				All blocks with swivel are available with snap shackle							



Double with swivel



Double with swivel and becket



Triple with swivel

Delrin sheaves Cat.no.	Ball bearing alu. sheaves Cat.no.	Sheave sizes	Max working load	Delrin sheaves Cat.no.	Ball bearing alu. sheaves Cat.no.	Sheave sizes	Max working load	Delrin sheaves Cat.no.	Ball bearing alu. sheaves Cat.no.	Sheave sizes	Max working load
00809	700809	75 x 20 mm	1800 kg	00810	700810	75 x 20 mm	1800 kg	00819	700819	75 x 20 mm	1800 kg
	700909	100 x 25 mm	2800 kg		700910	100 x 25 mm	2800 kg		700919	100 x 25 mm	2800 kg

Big Boat Aluminium Blocks - Ball Bearing



Triple with swivel and becket

Our big boat blocks have aluminium ball bearing sheaves and are only available with black anodised aluminium sides.

Blocks with plan bearing delrin sheaves are only available with sides in natural.



Double cheek block with fasteners



Cheek block with fasteners

Delrin sheaves Cat.no.	Ball bearing alu. sheaves Cat.no.	Sheave sizes	Max working load	Delrin sheaves Cat.no.	Ball bearing alu. sheaves Cat.no.	Sheave sizes	Max working load	Delrin sheaves Cat.no.	Ball bearing alu. sheaves Cat.no.	Sheave sizes	Max working load
00820	700820	75 x 20 mm	1800 kg	00812	700812	75 x 20 mm	1800 kg	00811	700811	75 x 20 mm	1800 kg
	700920	100 x 25 mm	2800 kg		700912	100 x 25 mm	2800 kg		700911	100 x 25 mm	2800 kg



Fiddle with swivel



Fiddle with swivel and becket



Fiddle with swivel and cam cleat

Delrin sheaves Cat.no.	Ball bearing alu. sheaves Cat.no.	Sheave sizes	Max working load	Delrin sheaves Cat.no.	Ball bearing alu. sheaves Cat.no.	Sheave sizes	Max working load	Delrin sheaves Cat.no.	Ball bearing alu. sheaves Cat.no.	Sheave sizes	Max working load
00814	700814	40/75 x 20 mm	1800 kg	00815	700815	40/75 x 20 mm	1800 kg	00817	700817	40/75 x 20 mm	1800 kg



Stainless Steel Blocks - Plan Bearing



Single



Single stand-up



Single



Single with becket



Single



Single with becket

Cat.no.	Sheave sizes	Max working load	Cat.no.	Sheave sizes	Max working load	Cat.no.	Sheave sizes	Max working load	Cat.no.	Sheave sizes	Max working load
010699	20 x 9 mm	kg	010701	25 x 10 mm	140 kg	010001	35 x 12 mm	300 kg	010002	35 x 12 mm	300 kg
010700	20 x 9 mm	kg	010702	25 x 10 mm	140 kg	010101	35 x 10 mm	300 kg	010102	35 x 10 mm	300 kg
						010201	45 x 12 mm	500 kg	010202	45 x 12 mm	500 kg
						010301	45 x 16 mm	625 kg	010302	45 x 16 mm	625 kg
						013012	57 x 16 mm	775 kg	013022	57 x 16 mm	775 kg
						010401	65 x 16 mm	950 kg	010402	65 x 16 mm	950 kg



Single with swivel



Single with snap shackle



Single with becket



Single with swivel plate

Cat.no.	Sheave sizes	Max working load	Cat.no.	Sheave sizes	Max working load	Cat.no.	Sheave sizes	Max working load	Cat.no.	Sheave sizes	Max working load
010103	35 x 10 mm	300 kg	010123	35 x 10 mm	300 kg	010104	35 x 10 mm	300 kg	010105	35 x 10 mm	300 kg
010203	45 x 12 mm	500 kg	010223	45 x 12 mm	500 kg	010204	45 x 12 mm	500 kg	010205	45 x 12 mm	500 kg
010303	45 x 16 mm	625 kg	010323	45 x 16 mm	625 kg	010304	45 x 16 mm	625 kg	010305	45 x 16 mm	625 kg
013032	57 x 16 mm	775 kg	013232	57 x 16 mm	775 kg	013042	57 x 16 mm	775 kg			
010403	65 x 16 mm	950 kg	010423	65 x 16 mm	950 kg	010404	65 x 16 mm	950 kg			

All blocks with swivel are available with snap shackle

Stainless Steel Blocks - Plan Bearing



Spring base stand-up block



Single with becket and swivel plate



Spring base stand-up block with becket



Double

Cat.no.	Sheave sizes	Max working load	Cat.no.	Sheave sizes	Max working load	Cat.no.	Sheave sizes	Max working load	Cat.no.	Sheave sizes	Max working load
013052	57 x 16 mm	775 kg	010106	35 x 10 mm	300 kg	013062	57 x 16 mm	775 kg	010107	35 x 10 mm	300 kg
010405	65 x 16 mm	950 kg	010206	45 x 12 mm	500 kg	010406	65 x 16 mm	950 kg	010207	45 x 12 mm	500 kg
Also available with aluminium sheave for rope or wire			010306	45 x 16 mm	625 kg	Also available with aluminium sheave for rope or wire			010307	45 x 16 mm	625 kg



Double with becket



Double with swivel

Cat.no.	Sheave sizes	Max working load	Cat.no.	Sheave sizes	Max working load
010108	35 x 10 mm	300 kg	010109	35 x 10 mm	300 kg
010208	45 x 12 mm	500 kg	010209	45 x 12 mm	500 kg
010308	45 x 16 mm	625 kg	010309	45 x 16 mm	625 kg
			013092	57 x 16 mm	775 kg
			010409	65 x 16 mm	950 kg

Universal swivel head

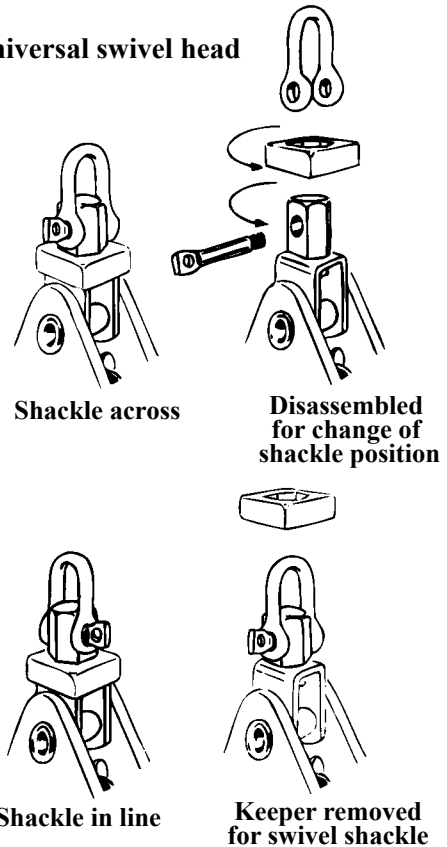



Double with swivel and becket



Fiddle



Fiddle with becket



Fiddle with swivel

Cat.no.	Sheave sizes	Max working load	Cat.no.	Sheave sizes	Max working load	Cat.no.	Sheave sizes	Max working load	Cat.no.	Sheave sizes	Max working load
010110	35 x 10 mm	300 kg	010112	45/25 x 10 mm	300 kg	010113	45/25 x 10 mm	300 kg	010114	45/25 x 10 mm	300 kg
010210	45 x 12 mm	500 kg	010212	57/32 x 12 mm	500 kg	010213	57/32 x 12 mm	500 kg	010214	57/32 x 12 mm	500 kg
010310	45 x 16 mm	625 kg	010312	57/32 x 16 mm	625 kg	010313	57/32 x 16 mm	625 kg	010314	57/32 x 16 mm	625 kg
013102	57 x 16 mm	775 kg									
010410	65 x 16 mm	950 kg									



Fiddle with swivel and becket



Fiddle with cam cleat adjustable to 5 positions



Fiddle with swivel and cam cleat adjustable to 5 positions



Fiddle with snap shackle and cam cleat adjustable to 5 positions

Cat.no.	Sheave sizes	Max working load	Cat.no.	Sheave sizes	Max working load	Cat.no.	Sheave sizes	Max working load	Cat.no.	Sheave sizes	Max working load
010115	45/25 x 10 mm	300 kg	010116	45/25 x 10 mm	300 kg	010117	45/25 x 10 mm	300 kg	010127	45/25 x 10 mm	300 kg
010215	57/32 x 12 mm	500 kg	010216	57/32 x 12 mm	500 kg	010217	57/32 x 12 mm	500 kg	010227	57/32 x 12 mm	500 kg
010315	57/32 x 16 mm	625 kg	010316	57/32 x 16 mm	625 kg	010317	57/32 x 16 mm	625 kg	010327	57/32 x 16 mm	625 kg



Triple with swivel



Triple with swivel and becket



Triple with swivel, becket and cam cleat

Cat.no.	Sheave sizes	Max working load	Cat.no.	Sheave sizes	Max working load	Cat.no.	Sheave sizes	Max working load
010119	35 x 10 mm	300 kg	010120	35 x 10 mm	300 kg	010221	45 x 12 mm	500 kg
010219	45 x 12 mm	500 kg	010220	45 x 12 mm	500 kg	013212	57 x 16 mm	775 kg
010319	45 x 16 mm	625 kg	010320	45 x 16 mm	625 kg	010421	65 x 16 mm	950 kg
013192	57 x 16 mm	775 kg	013202	57 x 16 mm	775 kg			
010419	65 x 16 mm	950 kg	010420	65 x 16 mm	950 kg			

Mainsheet tackle



Wire block with aluminium sheave



Block with swivel and aluminium sheave for rope and wire

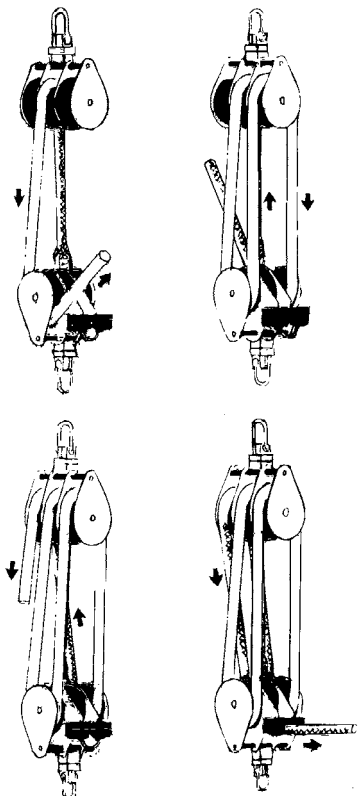

Method of reeving triple purchase with blocks having central becket and exit from centre sheave

Cat.no.	Sheave sizes	Max working load	Cat.no.	Sheave sizes	Max working load
010351	35 x 8 mm	300 kg	010454	45 x 12 mm	500 kg
010451	45 x 8 mm	775 kg	010455	57 x 16 mm	775 kg
010551	65 x 12 mm	950 kg	010456	65 x 16 mm	950 kg



Aluminium Lead Blocks



Check block



Check block with curved base



Heavy duty check block

Cat.no.	Sheave sizes	Max working load	Cat.no.	Sheave sizes	Max working load	Cat.no.	Sheave sizes	Length	Width	Height	Max working load
00111	35 x 10 mm	300 kg	00118	35 x 10 mm	300 kg	05111 single	65 x 23 mm	115 mm	69 mm	37 mm	2000 kg
00211	45 x 12 mm	500 kg	00218	45 x 12 mm	500 kg	05112 double	65 x 23 mm	115 mm	69 mm	68 mm	2000 kg
00311	45 x 16 mm	625 kg	00318	45 x 16 mm	625 kg						
00411	65 x 16 mm	775 kg									



Lead block



Lead block

Cat.no.	Sheaves	Sheave sizes	Dimensions L. W. H.	Cat.no.	Sheaves	Sheave sizes	Dimensions L. W. H.
21635	2	35 x 16 mm	116 x 40 x 24 mm	21232	2	32 x 12 mm	138 x 35 x 19 mm
31635	3	35 x 16 mm	161 x 40 x 24 mm	31232	3	32 x 12 mm	178 x 35 x 19 mm
41635	4	35 x 16 mm	206 x 40 x 24 mm	41232	4	32 x 12 mm	218 x 35 x 19 mm
51635	5	35 x 16 mm	251 x 40 x 24 mm	51232	5	32 x 12 mm	258 x 35 x 19 mm
61635	6	35 x 16 mm	296 x 40 x 24 mm	61232	6	32 x 12 mm	298 x 35 x 19 mm
				21645	2	45 x 16 mm	182 x 45 x 25 mm
				31645	3	45 x 16 mm	237 x 45 x 25 mm
				41645	4	45 x 16 mm	292 x 45 x 25 mm
				51645	5	45 x 16 mm	348 x 45 x 25 mm
				21850	2	49 x 18 mm	208 x 50 x 31 mm
				31850	3	49 x 18 mm	269 x 50 x 31 mm
				41850	4	49 x 18 mm	330 x 50 x 31 mm



Lead block



Lead block

Cat.no.	Sheaves	Sheave size	Dimensions L. W. H.	Cat.no.	Sheaves	Sheave size	Dimensions L. W. H.
416355	5	35 x 16/25 x 16 mm	206 x 40 x 24 mm	416356	6	35 x 16/35 x 8 mm	206 x 40 x 24 mm

Aluminium / Stainless Steel Lead Blocks



Ball bearing cheek block



Heavy duty cheek block with aluminium sheave and needle roller bearings

Cat.no.	Sheave size	Max working load	Cat.no.	Sheave sizes	Lenght	Width	Height	Max working load
700311	45 x 16 mm	625 kg	705111 single	65 x 23 mm	115 mm	69 mm	37 mm	2000 kg
			705112 double	65 x 23 mm	115 mm	69 mm	68 mm	2000 kg



Ball bearing lead block



Furling lead block

Cat.no.	Sheaves	Sheave sizes	Dimensions L. W. H.	Cat.no.	Sheave size
721645	2	45 x 16 mm	182 x 45 x 25 mm	111232	32 x 12 mm to be mounted with 2 x 5 mm screws
731645	3	45 x 16 mm	237 x 45 x 25 mm		
741645	4	45 x 16 mm	292 x 45 x 25 mm		
751645	5	45 x 16 mm	348 x 45 x 25 mm		



Cheek block



Cheek block with fasteners



Cheek block



Universal steering pulley for wire

Cat.no.	Sheave sizes	Max working load	Cat.no.	Sheave sizes	Max working load	Cat.no.	Sheave sizes	Max working load	Cat.no.	Sheave sizes	Max working load
010011	35 x 12 mm	300 kg	010311	45 x 16 mm	625 kg	111223	44 x 22.5 mm	625 kg	014100	100 x 17 mm	925 kg
010111	35 x 10 mm	300 kg	010411	65 x 16 mm	775 kg						
010211	45 x 12 mm	500 kg									



Halyard Stoppers

Our range of halyard stoppers gives a firm hold on the rope without damaging the rope tails



Halyard stopper rope 6-16 mm



Halyard stopper rope 6-16 mm

Cat.no.		Dimensions	L.	W.	H.	Cat.no.		Dimensions	L.	W.	H.
00611	Single		90	25	52 mm	00610	Single		64	69	27 mm
00612	Double		90	49	52 mm						
00613	Triple		90	72	52 mm						

Anchor Line Cassettes

The OH Anchor Line Cassette has a strong aluminium body with a stainless steel AISI 316 fitting which allows easy mounting on pulpit or stanchions using two 8 mm bolts.



Is also available in a "special version" for flat mounting, e.g. under anchor well hatches or cockpit hatches.

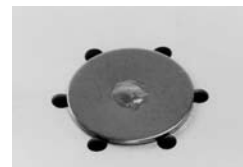

Cat.no.		Webbing length		Breaking load
835025	with polyester webbing 25 mm	25 m	outside diameter 350 mm	2500 kg
840035	with polyester webbing 25 mm	35 m	outside diameter 400 mm	2500 kg
846050	with polyester webbing 25 mm	50 m	outside diameter 460 mm	2500 kg

Cam Cleats



Washer for
5 mm screw



Fairlead for cam cleat



Aluminium cam cleat
with fasteners



Aluminium cam cleat double
with fasteners

Cat.no.	Diameter	Cat.no.	Cat.no.	Dimensions			Rope Diameter	Dimensions			Rope Diameter
				L.	W.	H.		L.	W.	H.	
810727	13.5 mm	007510	For 001510	001510	63 x 28 x 21 mm	4 - 10 mm	001816	94 x 38 x 41 mm	10 - 12 mm		
810728	21.0 mm	008815	For 001815	001815	83 x 36 x 26 mm	5 - 16 mm					

Tracks - Reefing Slides

The tracks are shown
in actual sizes

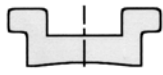

Track 20 mm

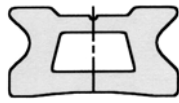

Track 22 mm

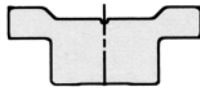

Track 25 mm

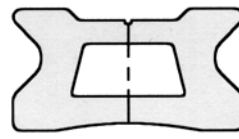

Track 30 mm

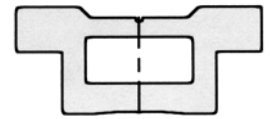

Track 32 mm

Cat.no.	Lengths	Cat.no.	Lengths	Cat.no.	Lengths	Cat.no.	Lengths	Cat.no.	Lengths
03310	500 mm	03320	1.0 m	03330	1.0 m	03340	1.0 m	03350	1.0 m
03311	740 mm	03321	1.5 m	03331	1.5 m	03341	1.5 m	03351	1.5 m
03312	980 mm	03322	2.0 m	03332	2.0 m	03342	2.0 m	03352	2.0 m
03313	1535 mm	03323	2.5 m	03333	2.5 m	03343	2.5 m	03353	2.5 m
03314	2015 mm	03324	3.0 m	03334	3.0 m	03344	3.0 m	03354	3.0 m
03301	End stop	03325	4.0 m	03335	4.0 m	03345	4.0 m	03355	4.0 m
		03326	5.0 m	03336	5.0 m	03346	5.0 m	03356	5.0 m
		03327	6.0 m	03337	6.0 m	03347	6.0 m	03357	6.0 m
		03302	End stop	03305	End stop	03303	End stop	03306	End stop
		03370	Track assembly			03371	Track assembly		



Genoa slide



Slide for slab reefing



Slide for slab reefing with block and eye

Cat.no.	Aluminium	Cat.no.	Aluminium	Cat.no.	Aluminium
02000	for 20 mm track	02003	for 20 mm track with eye	02005	for 20 mm



Genoa slide with block



Set for adjusting the sprayhood/bimini

Cat.no.	Aluminium	Cat.no.	
02010	for 20 mm track sheave size 35 x 12 mm	830050	2 x slides, 2 x tracks, 25 mm (1 m as standard) and 4 x end stops The slides are made of stainless steel with a stop and swivel that can turn 360°.



Stainless Steel Genoa - Reefing Slides



Genoa slide

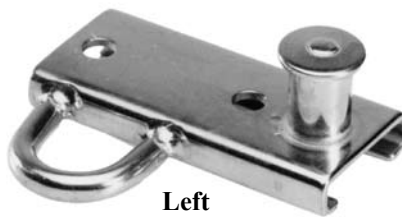

Left

Slide for slab reefing



Adjustable stop

Cat.no.		Cat.no.		Cat.no.	
02500	for 25 mm track	02502 02503	for 25 mm track eye right for 25 mm track eye left	02504	for 25 mm track



Left

Slide for slab reefing with block and eye



Genoa slide with block



Genoa slide with block and ball bearing sheave

Cat.no.		Cat.no.		Cat.no.	
02505 02506	for 25 mm track eye left for 25 mm track eye right	02514	for 25 mm track sheave size 35 x 16 mm	702514	for 25 mm track sheave size 35 x 16 mm

Genoa cars



Genoa car with eye for line control

Repair set containing:
Delrin sheave, bushing, bolt and nut
Cat.no. 350001 for 22 and 25 mm cars
Cat.no. 350003 for 30 and 32 mm cars

Repair set containing:
Alu. sheave with balls, bolt and nut
Cat.no. 350002 for 22 and 25 mm cars
Cat.no. 350004 for 30 and 32 mm cars



Genoa car with stop

Cat.no.		Cat.no.	
02515 02530 03215 03230	for 25 mm track, delrin sheave for 25 mm track, alu. ball sheave for 32 mm track, delrin sheave for 32 mm track, alu. ball sheave	02516 02529 03216 03229	for 25 mm track with delrin sheave for 25 mm track with alu. ball sheave for 32 mm track with delrin sheave for 32 mm track with alu. ball sheave



Genoa car with block for line control



Genoa car with shackle and stop



Adjustable stop

Cat.no.		Cat.no.		Cat.no.	
02531	for 25 mm track with alu. ball sheave	02525	for 25 mm track	02517	for 25 mm track
02533	for 25 mm track with delrin sheave	03225	for 32 mm track	03217	for 32 mm track
03231	for 32 mm track with alu. ball sheave				
03233	for 32 mm track with delrin sheave				



Stop with block



Stop with block and becket



Spinnaker pole car with eye for line control

Cat.no.		Cat.no.		Cat.no.	
02526	for 25 mm track	02535	for 25 mm track	02527	for 25 mm track, ring (inside 32 mm)
03226	for 32 mm track	03235	for 32 mm track	03227	for 32 mm track, ring (inside 40 mm)



Control block with cam cleat



Control block with becket and cam cleat

Cat.no.		Cat.no.	
02519	for 25 mm track with delrin sheave - port	02537	for 25 mm track with delrin sheave - port
02520	for 25 mm track with delrin sheave - starboard	02538	for 25 mm track with delrin sheave - starboard
02521	for 25 mm track with alu. ball sheave - port	02539	for 25 mm track with alu. ball sheave - port
02523	for 25 mm track with alu. ball sheave - starboard	02540	for 25 mm track with alu. ball sheave - starboard
03219	for 32 mm track with delrin sheave - port	03237	for 32 mm track with delrin sheave - port
03220	for 32 mm track with delrin sheave - starboard	03238	for 32 mm track with delrin sheave - starboard
03221	for 32 mm track with alu. ball sheave - port	03239	for 32 mm track with alu. ball sheave - port
03223	for 32 mm track with alu. ball sheave - starboard	03240	for 32 mm track with alu. ball sheave - starboard



Spinnaker pole car with stop



Spinnaker pole car with blocks for line control

Cat.no.		Cat.no.	
02528	for 25 mm track with ring (inside 32 mm)	02534	for 25 mm track with ring (inside 32 mm)
03228	for 32 mm track with ring (inside 40 mm)	03234	for 32 mm track with ring (inside 40 mm)



AISI 316 Skin- and Tube Fittings

We only use stainless steel AISI 316 for our skin- (through hull) and tube fittings to be able to supply a very reliable product produced for utmost safety and longest lifetime. Different materials should not be used in combination, as galvanic corrosion can occur. AISI 316 for eminent corrosion resistance in sea water.

Be aware that most ball valves in stainless steel AISI 316 only carry a ball of stainless steel 304. Our range of ball valves have housing, axles, as well as balls in stainless steel AISI 316 and seatings in PTFE (Teflon)

Our ball valves, skin- and tube fittings are CE approved



Lock nut



Countersunk skin fitting



Skin fitting



Hose nipple

Cat.no.	Sizes	Cat.no.	Sizes	Cat.no.	Sizes	Cat.no.	Sizes
821411	3/8"	821140	1/2" x 45 mm	821150	1/2" x 45 mm	821350	1/2" x 21 mm
821412	1/2"	821141	3/4" x 50 mm	821151	3/4" x 50 mm	821351	3/4" x 26 mm
821413	3/4"	821142	1" x 50 mm	821152	1" x 50 mm	821352	1" x 33 mm
821414	1"	821143	1 1/4" x 50 mm	821153	1 1/4" x 50 mm	821353	1 1/4" x 42 mm
821415	1 1/4"	821144	1 1/2" x 55 mm	821154	1 1/2" x 55 mm	821354	1 1/2" x 48 mm
821416	1 1/2"	821145	2" x 80 mm	821155	2" x 80 mm	821355	2" x 59 mm
821417	2"	Also available in lengths of 70 and 100 mm - please see our price list.		Also available in lengths of 70 and 100 mm - please see our price list.			



Hose nipple 3/8" - 3/4"



Hose nipple 1" - 2"



Elbow 90



Street elbow 90

Cat.no.	Sizes	Cat.no.	Sizes	Cat.no.	Sizes	Cat.no.	Sizes
821339	3/8" x 8 mm	821343	1" x 25 mm	821361	3/8"	821371	3/8"
821340	1/2" x 9 mm	821336	1" x 32 mm	821362	1/2"	821372	1/2"
821341	1/2" x 14 mm	821344	1 1/4" x 32 mm	821363	3/4"	821373	3/4"
821334	1/2" x 16 mm	821335	1 1/4" x 38 mm	821364	1"	821374	1"
821338	1/2" x 19 mm	821345	1 1/2" x 39 mm	821365	1 1/4"	821375	1 1/4"
821342	3/4" x 19 mm	821346	2" x 51 mm	821366	1 1/2"	821376	1 1/2"
821337	3/4" x 25 mm			821367	2"	821377	2"



Elbow 45



Hexagon bushing



Hexagon nipple



Socket plain



Tee

Cat.no.	Sizes	Cat.no.	Sizes	Cat.no.	Sizes	Cat.no.	Sizes	Cat.no.	Sizes
821381	3/8"	821391	3/8" - 1/4"	821401	3/8"	821421	3/8"	821431	3/8"
821382	1/2"	821392	1/2" - 3/8"	821402	1/2"	821422	1/2"	821432	1/2"
821383	3/4"	821393	3/4" - 1/2"	821403	3/4"	821423	3/4"	821433	3/4"
821384	1"	821394	1" - 3/4"	821404	1"	821424	1"	821434	1"
821385	1 1/4"	821395	1 1/4" - 1"	821405	1 1/4"	821425	1 1/4"	821435	1 1/4"
821386	1 1/2"	821396	1 1/2" - 1 1/4"	821406	1 1/2"	821426	1 1/2"	821436	1 1/2"
821387	2"	821397	2" - 1 1/2"	821407	2"	821427	2"	821437	2"

Ball Valves - Shackles - Springs - Split Rings - Swivels



Ball valve



Fillerserve for water intake



3-way (L) Ball valve

Cat.no.	Sizes	Cat.no.	Sizes	Cat.no.	Sizes
821249	3/8"	821130	For skin fittings up to 1"	821262	3/4"
821250	1/2"	821131	For skin fittings up to 2"	821263	1"
821251	3/4"			821264	1 1/4"
821252	1"			821265	1 1/2"
821253	1 1/4"				
821254	1 1/2"				
821255	2"				

All stainless steel AISI 316

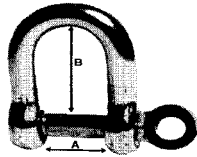

Shackle, screwed pin with eye

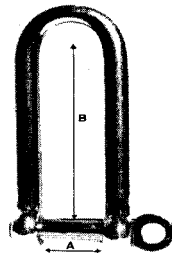

Shackle, screwed pin with eye

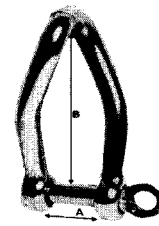

Shackle twisted, screwed pin with eye

Cat.no.	Size	Dimensions A	Dimensions B	Breaking load	Cat.no.	Sizes	Dimensions A	Dimensions B	Breaking load	Cat.no.	Sizes	Dimensions A	Dimensions B	Breaking load
810601	M5	10 mm	17 mm	1500 kg	810615	M5	11 mm	40 mm	1600 kg	810610	M5	11 mm	20 mm	1200 kg
810602	M6	12 mm	19 mm	1800 kg	810616	M6	14 mm	50 mm	1950 kg	810611	M6	14 mm	25 mm	1750 kg
810603	M8	16 mm	30 mm	4300 kg	810617	M8	16 mm	64 mm	3000 kg	810612	M8	16 mm	32 mm	2500 kg
810604	M10	20 mm	33 mm	5700 kg										
810605	M12	24 mm	40 mm	8000 kg										
810607	M14	28 mm	48 mm	11000 kg										
810618	M5		bow	1200 kg										

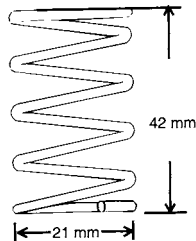

Spring cylindrical

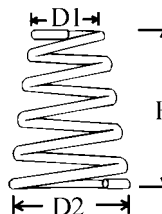

Spring conic



Split rings

Cat.no.	Dimensions B x H	Cat.no.	Dimensions D1 x D2 x H	Cat.no.	Dimensions
810915	21 x 42 mm	810916	12 x 21 x 33 x 2.0 mm	821101	1.00 x 11 mm
		810942	18 x 33 x 39 x 3.0 mm	821102	1.25 x 15 mm
		810943	20 x 42 x 44 x 3.5 mm	821103	1.50 x 19 mm
		810944	29 x 59 x 45 x 5.0 mm	821104	2.00 x 23 mm



Swivel



Swivel plate



Base eye plate



Pad Eye

Cat.no.	Width	Pin	Cat.no.	Base Dia.	Fastenings	Cat.no.	Base size	Fastenings	Cat.no.	Base Dia.	Fastenings
00724	10 x 10 mm	5 mm	00725	42 mm	4 x 4 mm	00726	54 x 80 mm	4 x 6 mm	00727	50 mm	4 x 5 mm
									00728	60 mm	4 x 6 mm
									00729	75 mm	4 x 8 mm
									00730	100 mm	4 x 12 mm



Sheaves

Delrin/PET* sheave

Cat.no.	A	B	C	D
810000	25 mm	10 mm	11 mm	9.2 mm
810001	35 mm	10 mm	11 mm	9.2 mm
810002	45 mm	10 mm	11 mm	9.2 mm
810003	32 mm	12 mm	13 mm	9.2 mm
810004	35 mm	12 mm	13 mm	9.2 mm
810005	45 mm	12 mm	13 mm	9.2 mm
810006	57 mm	12 mm	13 mm	9.2 mm
810019	65 mm	14.5 mm	15 mm	12.2 mm
810007	32 mm	16 mm	17 mm	9.2 mm
810008	35 mm	16 mm	17 mm	9.2 mm
810016	35 mm	16 mm	17 mm	10.2 mm
810009	45 mm	16 mm	17 mm	9.2 mm
810010	57 mm	16 mm	17 mm	9.2 mm
810011	65 mm	16 mm	17 mm	9.2 mm
810013	49 mm	17.5 mm	18.3 mm	12.2 mm
810014	65 mm	17.5 mm	18.3 mm	12.2 mm
810017	40 mm	18 mm	19.5 mm	14.2 mm
810026*	75 mm	18 mm	19.5 mm	19.2 mm
810018	44 mm	21 mm	22.5 mm	12.2 mm
810039*	60 mm	23 mm	24.5 mm	16.2 mm
810015	65 mm	23 mm	24.5 mm	12.2 mm
810040*	100 mm	23 mm	24.5 mm	24.2 mm
810025	60 mm	31 mm	33 mm	12.2 mm
810041*	100 mm	43 mm	44.5 mm	24.2 mm

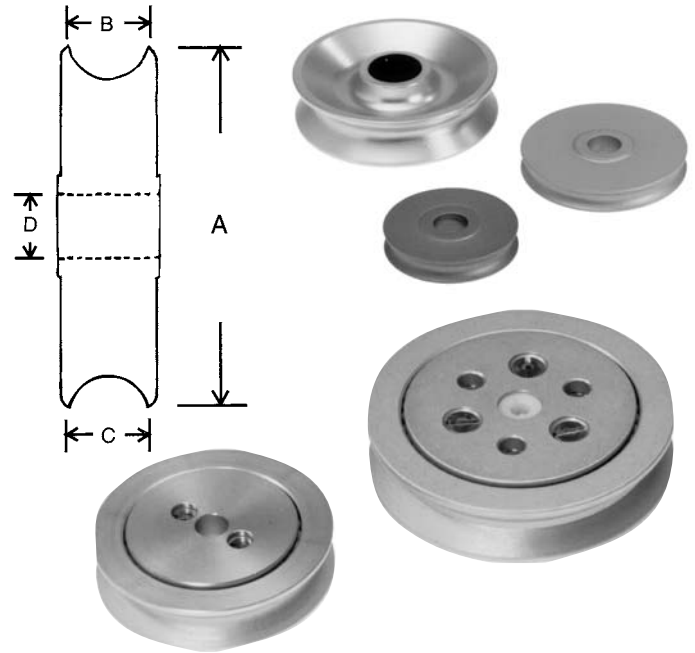

Aluminium sheave

Cat.no.	A	B	C	D
810100	35 mm	7.5 mm	8.5 mm	9.2 mm
810101	45 mm	7.5 mm	8.5 mm	9.2 mm
810102	32 mm	12 mm	13 mm	9.2 mm
810103	45 mm	12 mm	13 mm	9.2 mm
810110	65 mm	12 mm	13 mm	12.2 mm
810111	35 mm	16 mm	17 mm	10.2 mm
810104	45 mm	16 mm	17 mm	10.2 mm
810105	57 mm	16 mm	17 mm	10.2 mm
810106	65 mm	16 mm	17 mm	10.2 mm
810109	65 mm	18 mm	19 mm	14.2 mm

Aluminium sheave with ball bearing

Cat.no.	A	B	C	D
810146	68 mm	14.5 mm	16 mm	10.2 mm
810153	75 mm	14.5 mm	16 mm	10.2 mm
810154	100 mm	14.5 mm	16 mm	12.2 mm
810147	40 mm	18 mm	20 mm	8.2 mm
810150	75 mm	18 mm	20 mm	12.2 mm
810152	100 mm	23 mm	25 mm	12.2 mm

Pin Bolts

Pin bolts, stainless steel AISI 316

Cat.no.	A	B	C
821009	4 mm	22 mm	19.0 mm
821010	4 mm	30 mm	27.0 mm
821000	5 mm	16 mm	13.5 mm
821001	5 mm	20 mm	17.0 mm
821002	5 mm	23 mm	20.0 mm
821003	5 mm	27 mm	24.5 mm
821004	5 mm	34 mm	31.5 mm
821005	5 mm	41 mm	38.0 mm
821006	5 mm	47 mm	44.0 mm
821007	6 mm	22 mm	19.0 mm
821008	6 mm	30 mm	26.0 mm
821011	6 mm	33 mm	30.5 mm
821013	8 mm	28 mm	23.0 mm
821014	8 mm	35 mm	30.0 mm

Pin bolt with flat head, stainless steel AISI 316

Cat.no.	A	B	C
821012	9.5 mm	25 mm	21.5 mm
821026	9.5 mm	28 mm	23.0 mm
821038	9.5 mm	28 mm	26.0 mm
821015	9.5 mm	36 mm	31.5 mm
821016	9.5 mm	42 mm	38.0 mm
821017	11.0 mm	24 mm	18.0 mm
821018	11.0 mm	30 mm	25.0 mm
821019	11.0 mm	36 mm	30.0 mm
821031	12.0 mm	32 mm	28.0 mm
821020	13.0 mm	24 mm	18.0 mm
821021	13.0 mm	29 mm	25.0 mm
821022	13.0 mm	36 mm	31.0 mm
821023	13.0 mm	40 mm	33.5 mm
821036	15.0 mm	40 mm	34.0 mm
821024	15.0 mm	45 mm	38.0 mm
821037	16.0 mm	47.5 mm	40.0 mm
821039	18.0 mm	48.0 mm	40.5 mm
821025	25.0 mm	62 mm	58.0 mm

